

TECHNICAL INFORMATION FOR TGS2602

Technical Information for Air Quality Control Sensors

FIGARO
an ISO9001 company

The Figaro 2600 series is a new type thick film metal oxide semiconductor, screen printed gas sensor which offers miniaturization and lower power consumption. The TGS 2602 has high sensitivity not only to air contaminants which are emitted by cigarette smoke, but also to low concentrations of odorous gases such as ammonia and H₂S generated from waste materials in office and home environments.

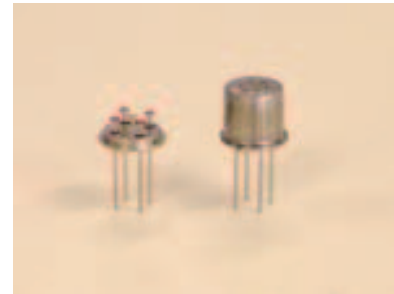

	<u>Page</u>
Basic Information and Specifications	
Features.....	2
Applications.....	2
Structure.....	2
Basic measuring circuit.....	2
Circuit & operating conditions.....	3
Specifications.....	3
Dimensions.....	3
Typical Sensitivity Characteristics	
Sensitivity to various gases.....	4
Temperature and humidity dependency.....	5-6
Heater voltage dependency.....	6
Gas response.....	7
Initial action.....	8
Long term characteristics.....	8-9
Reliability	
Effect of air flow.....	10
Cautions.....	11

IMPORTANT NOTE: OPERATING CONDITIONS IN WHICH FIGARO SENSORS ARE USED WILL VARY WITH EACH CUSTOMER'S SPECIFIC APPLICATIONS. FIGARO STRONGLY RECOMMENDS CONSULTING OUR TECHNICAL STAFF BEFORE DEPLOYING FIGARO SENSORS IN YOUR APPLICATION AND, IN PARTICULAR, WHEN CUSTOMER'S TARGET GASES ARE NOT LISTED HEREIN. FIGARO CANNOT ASSUME ANY RESPONSIBILITY FOR ANY USE OF ITS SENSORS IN A PRODUCT OR APPLICATION FOR WHICH SENSOR HAS NOT BEEN SPECIFICALLY TESTED BY FIGARO.

1. Basic Information and Specifications

1-1 Features

- * High sensitivity to VOCs and odorous gases
- * Low power consumption
- * High sensitivity to gaseous air contaminants
- * Long life
- * Small size

1-2 Applications

- * Air cleaners for indoor air cleaners
- * Air cleaners for vehicles
- * Air quality monitors

1-3 Structure

Figure 1 shows the structure of TGS2602. Using thick film techniques, the sensor material is printed on electrodes (noble metal) which have been printed onto an alumina substrate. The main sensing material of the sensor element is metal oxide semiconductor. One electrode is connected to pin No.2 and the other is connected to pin No.3. A metal oxide heater printed onto the reverse side of the substrate and connected to pins No.1 and No.4 heats the sensing material.

Lead wires are Pt-W and are connected to sensor pins which are made of Ni-plated Ni-Fe 50%.

The sensor base is made of Ni-plated steel. The sensor cap is made of stainless steel (SUS304).

1-4 Basic measuring circuit

Figure 2 shows the basic measuring circuit. Circuit voltage (V_C) is applied across the sensor element which has a resistance (R_S) between the sensor's two electrodes and the load resistor (R_L) connected in series. DC voltage is always required for the circuit voltage, and the polarity shown in Fig. 2 **must** be maintained. The sensor signal (V_{RL}) is measured indirectly as a change in voltage across the R_L . The R_S is obtained from the formula shown at the right.

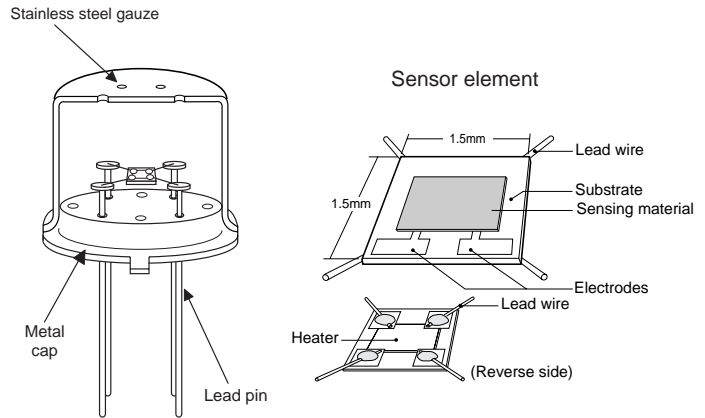

Fig. 1 - Sensor structure

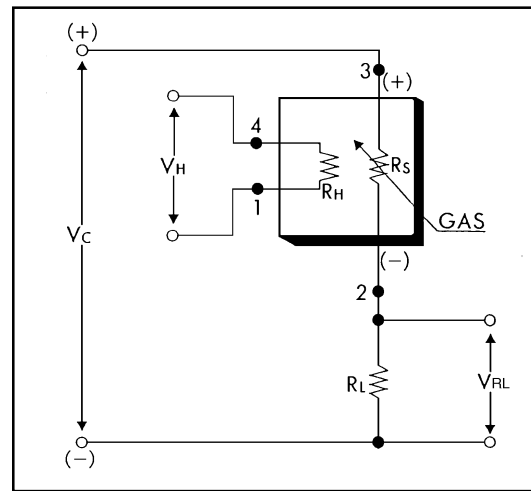

Fig. 2 - Basic measuring circuit

NOTE: In the case of V_H , there is no polarity, so pins 1 and 4 can be considered interchangeable. However, in the case of V_C , when used with DC power, pins 2 and 3 **must** be used as shown in the Figure above.

$$R_S = \frac{V_C - V_{out}}{V_{out}} \times R_L$$

Formula to determine R_S

1-5 Circuit & operating conditions

The ratings shown below should be maintained at all times to insure stable sensor performance:

Item	Specification
Circuit voltage (Vc)	5.0V ± 0.2V DC
Heater voltage (VH)	5.0V ± 0.2V DC/AC
Heater resistance (room temp.)	59Ω at room temp. (typical)
Load resistance (RL)	Variable (0.45kΩ min.)
Sensor power dissipation (Ps)	≤ 15mW
Operating conditions	-10°C ~ +50°C (w/o dew condensation) absolute humidity ≤ 41g/m ³
Storage conditions	-20°C ~ +60°C (w/o dew condensation) absolute humidity ≤ 41g/m ³
Optimal detection concentration	1~10ppm

1-6 Specifications **NOTE 1**

Item	Specification
Sensor resistance (air)	10kΩ ~ 100kΩ
Sensor resistance gradient (β)	0.15 ~ 0.5
$\beta = R_s(10\text{ppm EtOH})/R_s(\text{air})$	
Heater current	56 ± 5mA
Heater power consumption	280mW (typical)

NOTE 1: Sensitivity characteristics are obtained under the following standard test conditions:

(Standard test conditions)

Temperature and humidity: 20 ± 2°C, 65 ± 5% RH

Circuit conditions: Vc = 5.0 ± 0.05V DC

VH = 5.0 ± 0.05V DC

RL = 10.0kΩ ± 1%

Preheating period: 7 days or more under standard circuit conditions.

All sensor characteristics shown in this brochure represent typical characteristics. Actual characteristics vary from sensor to sensor and from production lot to production lot. The only characteristics warranted are those shown in the Specification table above.

1-7 Dimensions

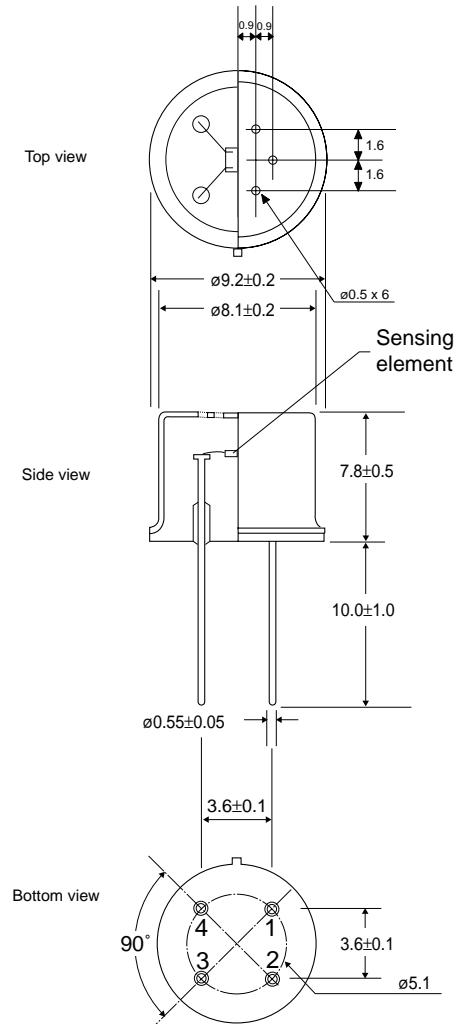

Pin connection:

- 1: Heater
- 2: Sensor electrode (-)
- 3: Sensor electrode (+)
- 4: Heater

Fig. 3 - Sensor dimensions

Mechanical Strength:

The sensor shall have no abnormal findings in its structure and shall satisfy the above electrical specifications after the following performance tests:

Withdrawal Force - withstand force of 5kg in each direction (pin from base)

Vibration - frequency-1000c/min., total amplitude-4mm, duration-one hour, direction-vertical

Shock - acceleration-100G, repeated 5 times

2. Typical Sensitivity Characteristics

2-1 Sensitivity to various gases

Figure 4 shows the relative sensitivity of TGS2602 to various gases. The Y-axis shows the ratio of the sensor resistance in various gases (R_s) to the sensor resistance in clean air (R_o) taken at standard test conditions of 20°C / 65%RH.

Figure 5 shows the relative sensitivity of TGS2602 to various gases in cigarette smoke. The Y-axis shows the ratio of the sensor resistance in cigarette smoke (R_s) to the sensor resistance in clean air (R_o) taken at standard test conditions of 20°C / 65%RH. This data was taken in a 20m³ room with cigarettes placed on a flat surface. The burning time for one cigarette was approximately 8 minutes. (Note: Generally, the activation point for an air cleaner would be around $R_s/R_o=0.85$, while the R_s/R_o for just one cigarette is as low as 0.65, making this sensor ideal for air cleaner application).

This data shows that TGS2602 has good sensitivity to low concentrations of air contaminants, including those found in cigarette smoke.

NOTE:

All sensor characteristics in this technical brochure represent typical sensor characteristics.

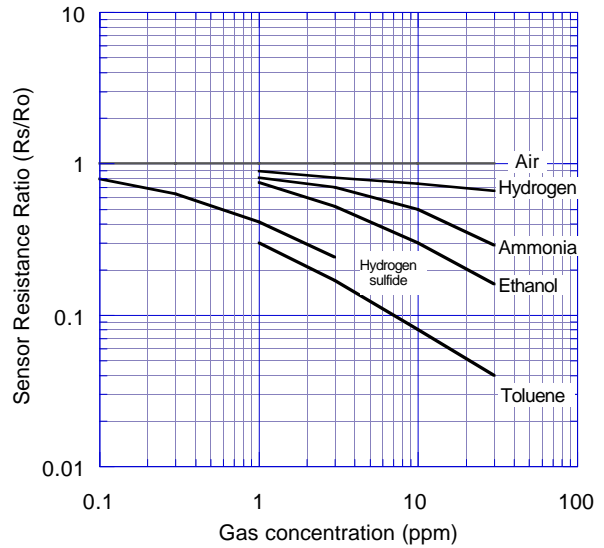

Fig. 4 - Sensitivity to various gases (R_s/R_o)

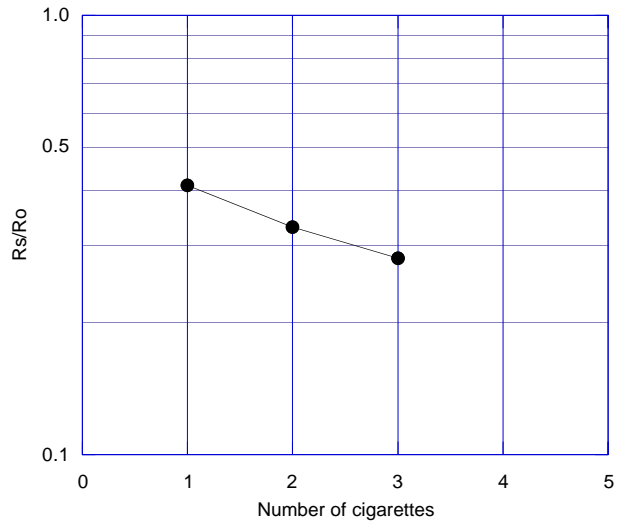

Fig. 5 - Sensitivity to cigarette smoke (R_s/R_o)

2-2 Temperature and humidity dependency

Figure 6 shows the temperature and humidity dependency of TGS2602 in clean air. The Y-axis shows the ratio of sensor resistance in clean air under various atmospheric conditions (R_s) to the sensor resistance in clean air at 20°C / 65%RH (R_o).

R.H. (°C)	40%R.H.	65%R.H.	85%R.H.	100%R.H.
-10				1.88
0				1.67
10	1.25	1.33	1.43	
20	0.95	1.00	1.07	
30	0.69	0.74	0.79	
40	0.49	0.52	0.55	
50	0.31	0.33	0.37	

Table 1 - Temperature and humidity dependency
(typical values of R_s/R_o for Fig. 6)

Table 1 shows a table of values of the sensor's resistance ratio (R_s/R_o) under the same conditions as those used to generate Figure 6.

Figure 7 shows the temperature and humidity dependency of TGS2602 in ethanol. The Y-axis shows the ratio of sensor resistance in 10ppm of ethanol under various atmospheric conditions (R_s) to the sensor resistance in clean air under the same atmospheric conditions (R_o).

This section demonstrates that, when used in the range of 10°C~50°C, sensitivity in air (Fig. 6) shows temperature dependency, but sensitivity in gas (Fig. 7) is relatively unaffected by temperature. As a result, temperature compensation for the sensor is not required, although is a greater accuracy is desired, temperature compensation for air values can be done.

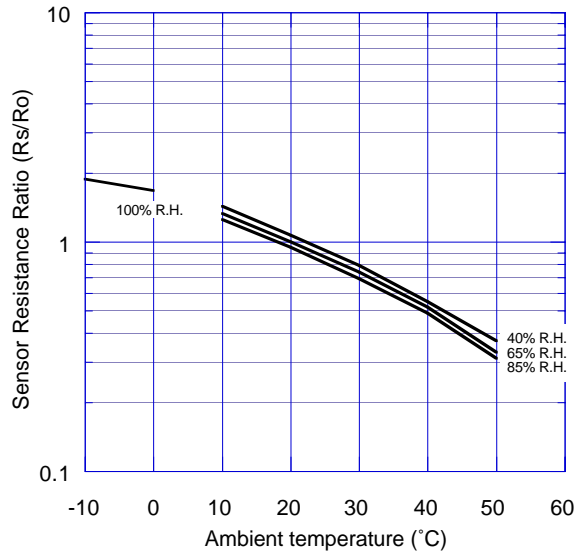

Fig. 6 - Temperature and humidity dependency (R_s/R_o) in clean air

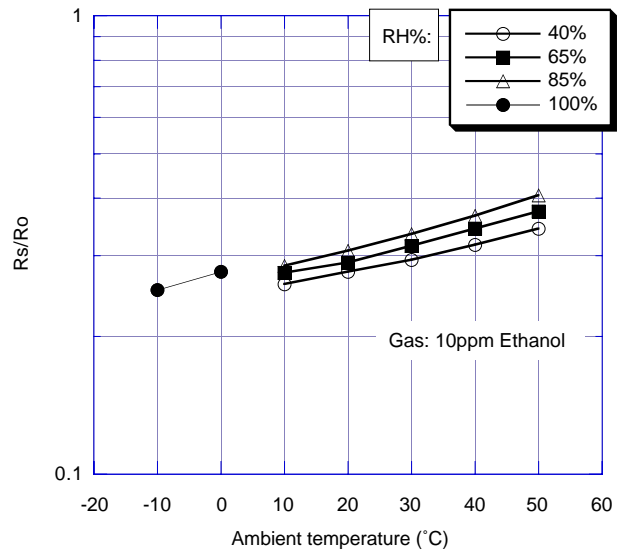

Fig. 7 - Temperature and humidity dependency (R_s/R_o) in 10ppm of ethanol

2-3 Heater voltage dependency

Figure 8 shows the change of the sensor resistance ratio in clean air according to variations in the heater voltage (VH). The Y-axis shows the ratio of sensor resistance in clean air at various heater voltages (Rs) compared to sensor resistance in clean air at VH=5.0V (Ro).

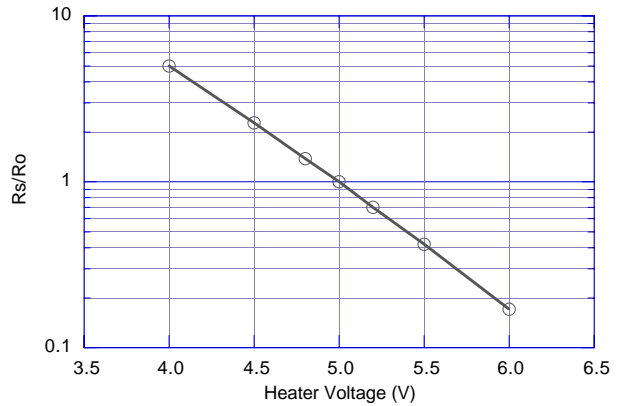

Fig. 8 - Heater voltage dependency in clean air

Figure 9 shows the change of the sensor resistance ratio in ethanol, ammonia, and hydrogen sulfide according to variations in the heater voltage (VH). The Y-axis shows the ratio of sensor resistance in gases at various heater voltages (Rs) compared to sensor resistance in clean air at the same heater voltage (Ro).

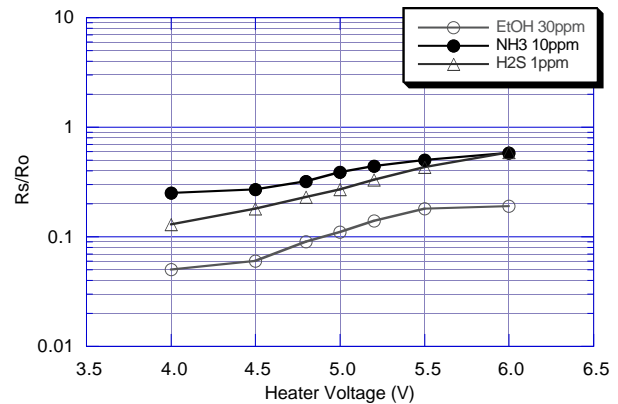

Fig. 9 - Heater voltage dependency in various gases

2-4 Gas response

Figure 10, 11, and 12 show the response pattern of the sensor when inserted into and later removed from 10ppm of ethanol, 10ppm of NH3, and 1ppm of H2S respectively after a 3 minute period. The Y-axis shows the ratio of sensor resistance over time (Rs) compared with sensor resistance in clean air just prior to insertion into each gas (Ro).

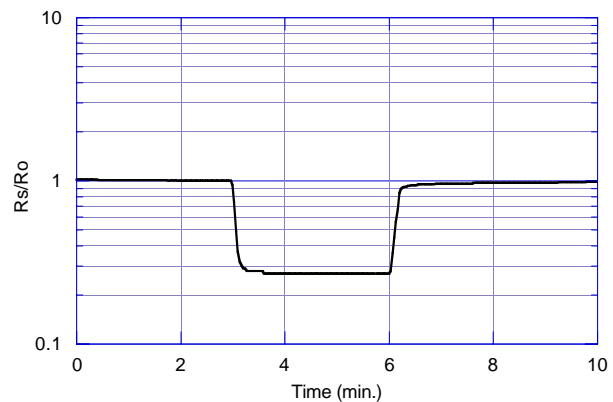

Fig. 10 - Gas response to EtOH

As these charts display, the sensor's response speed to the presence of gas is extremely quick, and when removed from gas, the sensor will recover back to its original value in a short period of time.

Figure 13 shows the response pattern of the sensor to the various gases found in cigarette smoke. The Y-axis shows the ratio of sensor resistance over time (R_s) compared with sensor resistance after 1 minute in clean air (R_o). This data was taken in a $20m^3$ room with cigarettes placed on a flat surface. The burning time for one cigarette was approximately 8 minutes.

This test consisted of the following sequence:

- 0- 5 min.: clean air ($20^{\circ}C / 65\%RH$)
- 5-13 min.: first cigarette burning
- 13-18 min.: no ventilation
- 18-26 min.: second cigarette burning
- 26-31 min.: no ventilation
- 31-39 min.: third cigarette burning
- 39-44 min.: no ventilation
- 44 min.: ventilation

(Note: Generally, the activation point for an air cleaner would be around $R_s/R_o=0.85$, while the R_s/R_o for just one cigarette is as low as 0.65).

This data demonstrates that TGS2602 is ideal for usage in air cleaners designed to ventilate when cigarette smoke and other air contaminants are present.

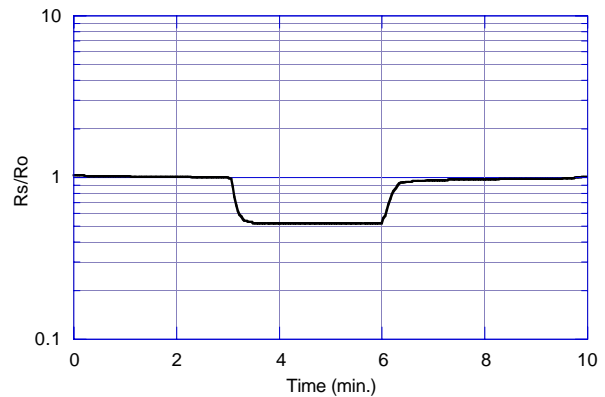

Fig. 11 - Gas response to ammonia

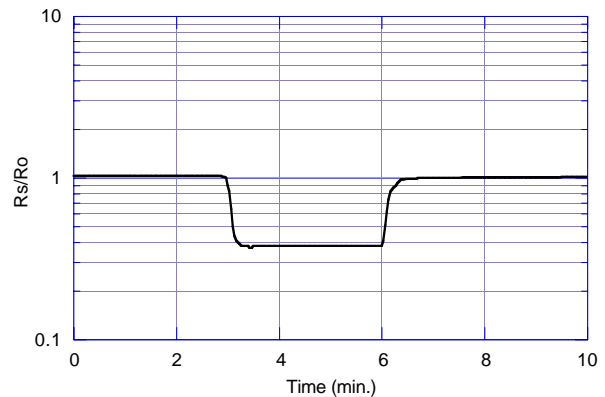

Fig. 12 - Gas response to H_2S

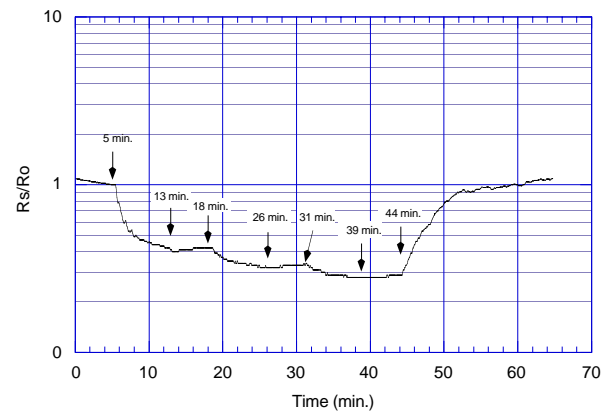

Fig. 13 - Response to cigarette smoke

2-5 Initial action

Figure 14 shows the initial action of the sensor resistance (R_s) for a sensor which is stored unenergized in normal air for 30 days and then energized in clean air. The Y-axis represents sensor resistance in clean air at various times after energizing (R_s) compared with sensor resistance 20 min. after energizing (R_o).

The R_s drops sharply for the first seconds after energizing, regardless of the presence of gases, and then reaches a stable level according to the ambient atmosphere. Such behavior during the warm-up process is called "Initial Action".

Since this 'initial action' may cause an air cleaner to activate unnecessarily during the initial moments after powering on, it is recommended that an initial delay circuit be incorporated into the device's design.

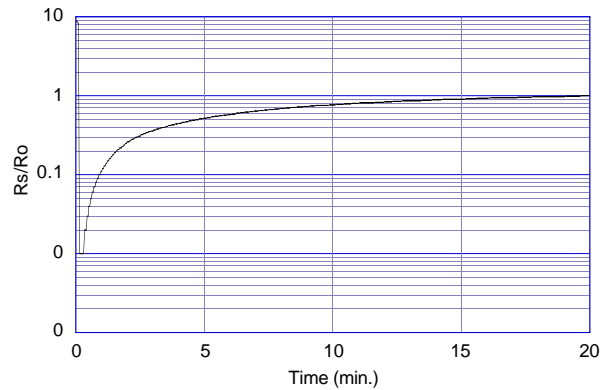

Fig. 14 - Initial action

2-6 Long-term characteristics

Figures 15 - 18 show the long-term stability of TGS2602 as measured for more than 150 days. In Figures 15 & 16, the sensor is first energized in normal air. Measurement for confirming sensor characteristics is conducted under standard test conditions. Figure 15 depicts sensor resistance in clean air over the test period, while in Figure 16 the Y-axis shows the ratio of sensor resistance in gases (R_s) compared with sensor resistance in fresh air on the same day (R_o).

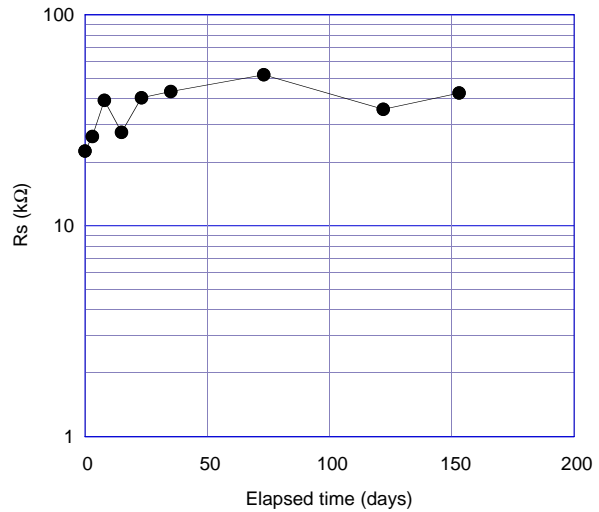

Fig. 15 - Long-term stability (continuous energizing) in clean air

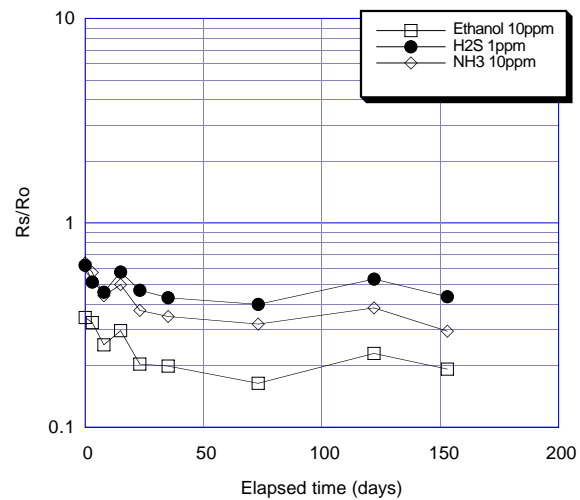

Fig. 16 - Long term stability (continuous energizing) in various gases

In Figures 17 & 18, the sensor is left unenergized in normal air for the entire test period except for the measurement period. Measurement for confirming sensor characteristics is conducted under standard test conditions. Figure 17 depicts sensor resistance in clean air over the test period, while in Figure 18 the Y-axis shows the ratio of sensor resistance in gases (Rs) compared with sensor resistance in fresh air on the same day (Ro).

3. Reliability

3-1 Effect of air flow

Figure 19-1 indicates the influence on the sensor's Rs in fresh air as caused by air flow directed through the top of the sensor. A test sample was powered under standard conditions ($20^{\circ}\pm 2^{\circ}\text{C} / 65\%\pm 10\%\text{RH}$) in calm air for one minute. For the next two minutes, the sensor is exposed to an air flow of 3~4m/second (or 7~8m/sec.). The sensor is then returned to calm air for another two minutes. The sensor's response to air flow can be seen by viewing the change ratio of Rs.

Figure 19-2 indicates the influence on the sensor's Rs in fresh air as caused by air flow directed at the sensor from the side. The test procedure is exactly the same as that described above for Figure 19-1, and the sensor's response to air flow is evidenced by the change ratio of Rs.

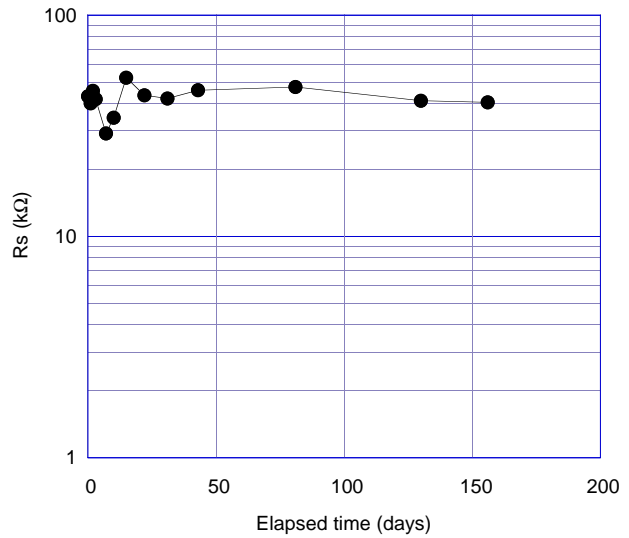

Fig. 17 - Long term stability (unenergized) in clean air

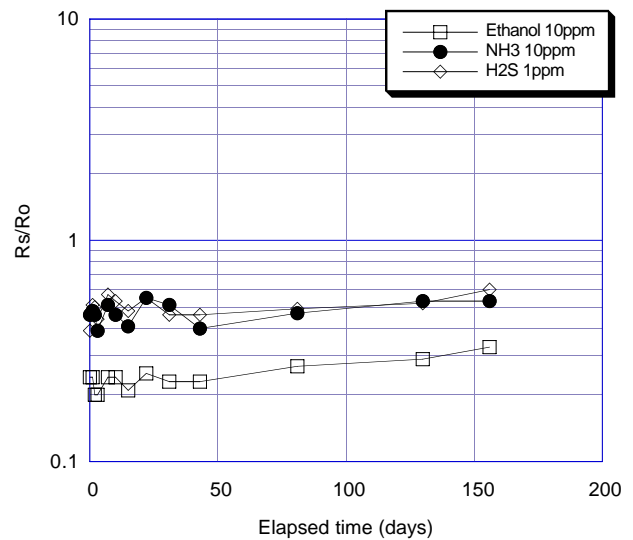

Fig. 18 - Long term stability (unenergized) in various gases

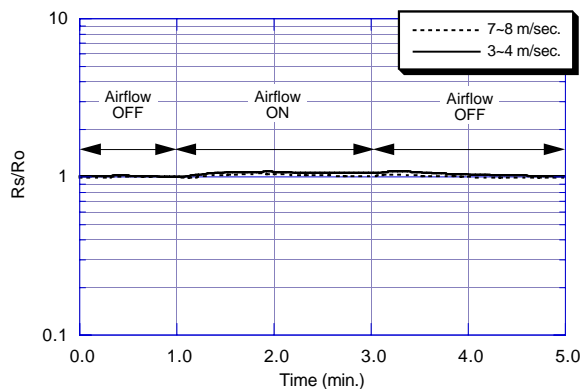

Fig. 19-1 - Effect of air flow through top of sensor

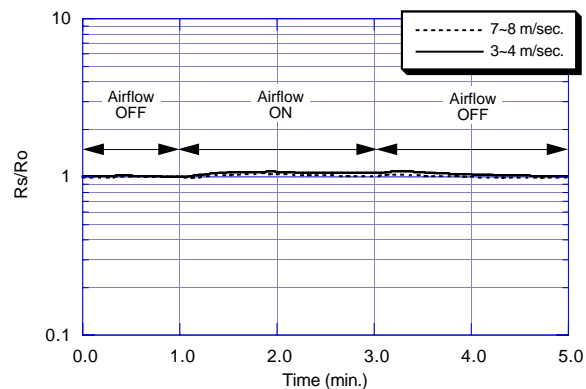

Fig. 19-2 - Effect of air flow across side of sensor

4 Cautions

4-1 Situations which must be avoided

1) Exposure to silicone vapors

If silicone vapors adsorb onto the sensor's surface, the sensing material will be coated, irreversibly inhibiting sensitivity. Avoid exposure where silicone adhesives, hair grooming materials, or silicone rubber/putty may be present.

2) Highly corrosive environment

High density exposure to corrosive materials such as H₂S, SO_x, Cl₂, HCl, etc. for extended periods may cause corrosion or breakage of the lead wires or heater material.

3) Contamination by alkaline metals

Sensor drift may occur when the sensor is contaminated by alkaline metals, especially salt water spray. This may also happen if the sensor is exposed to inorganic elements.

4) Contact with water

Sensor drift may occur due to soaking or splashing the sensor with water.

5) Freezing

If water freezes on the sensing surface, the sensing material would crack, altering characteristics.

6) Application of excessive voltage

If higher than specified voltage is applied to the sensor or the heater, lead wires and/or the heater may be damaged or sensor characteristics may drift, even if no physical damage or breakage occurs.

7) Operation in zero/low oxygen environment

TGS sensors require the presence of around 21% (ambient) oxygen in their operating environment in order to function properly and to exhibit characteristics described in Figaro's product literature. TGS sensors cannot properly operate in a zero or low oxygen content atmosphere.

4-2 Situations to be avoided whenever possible

1) Water condensation

Light condensation under conditions of indoor usage should not pose a problem for sensor performance.

However, if water condenses on the sensor's surface and remains for an extended period, sensor characteristics may drift.

2) Usage in high density of gas

Sensor performance may be affected if exposed to a high density of gas for a long period of time, regardless of the powering condition.

3) Storage for extended periods

When stored without powering for a long period, the sensor may show a reversible drift in resistance according to the environment in which it was stored. The sensor should be stored in a sealed bag containing clean air; do not use silica gel. *Note that as unpowered storage becomes longer, a longer preheating period is required to stabilize the sensor before usage.*

4) Long term exposure in adverse environment

Regardless of powering condition, if the sensor is exposed in extreme conditions such as very high humidity, extreme temperatures, or high contamination levels for a long period of time, sensor performance will be adversely affected.

5) Vibration

Excessive vibration may cause the sensor or lead wires to resonate and break. Usage of compressed air drivers/ultrasonic welders on assembly lines may generate such vibration, so please check this matter.

6) Shock

Breakage of lead wires may occur if the sensor is subjected to a strong shock.

7) Soldering

Ideally, sensors should be soldered manually. However, wave soldering can be done under the following conditions:

a) Suggested flux: rosin flux with minimal chlorine

b) Speed: 1-2 meters/min.

c) Preheating temperature: 100±20°C

d) Solder temperature: 250±10°C

e) Up to two passes through wave soldering machine allowed

Results of wave soldering cannot be guaranteed if conducted outside the above guidelines since some flux vapors may cause drift in sensor performance similar to the effects of silicone vapors.

Figaro USA Inc. and the manufacturer, Figaro Engineering Inc. (together referred to as Figaro) reserve the right to make changes without notice to any products herein to improve reliability, functioning or design. Information contained in this document is believed to be reliable. However, Figaro does not assume any liability arising out of the application or use of any product or circuit described herein; neither does it convey any license under its patent rights, nor the rights of others.

Figaro's products are not authorized for use as critical components in life support applications wherein a failure or malfunction of the products may result in injury or threat to life.